

①



ITEM	DESCRIPTION	WEIGHT	PART NO.
------	-------------	--------	----------

**SQUARE BASE ASSEMBLY:**

①	Aluminum .....	22.5 lbs. ....	PB-5335
	Aluminum, Heat Treated .....	22.5 lbs. ....	PB-5336
②	Alum w/ Steel Coupling .....	23.5 lbs. ....	PB-5341
③	Alum w/ Slip Fit .....	22.5 lbs. ....	PB-5339
④	Iron .....	76.0 lbs. ....	PB-5308

**OCTAGONAL BASE ASSEMBLY:**

⑤	Alum w/ Alum door .....	25.0 lbs. ....	PB-5349
⑥	Alum w/ Steel Coupling and Alum Door .....	27.0 lbs. ....	PB-5351
⑦	Alum w/ Slip Fit and Alum Door .....	25.0 lbs. ....	PB-5350
⑧	Iron w/ Iron door .....	78.0 lbs. ....	PB-5310

**Notes:**

1. AASHTO Certified Square Aluminum Base: All Aluminum square bases above are available with AASHTO Certifications and FHWA approval. Please specify by adding the Certification Part No. C-1001 in addition to the base part number.
2. All assemblies are supplied standard with stainless fasteners.
3. Please specify options when ordering.

②

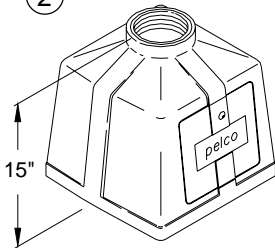

ITEM 1 & 2 OPTIONS
DOOR: Alum, Plastic, or Blank Plastic
SETSCREWS IN COLLAR: (1) 3/8" Hex Hd Bolt (3) 3/8" Soc Hd Setscrews
GROUNDING LUG
PAINT

③

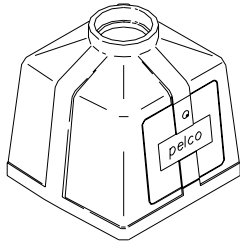

OPTIONS
DOOR: Alum, Plastic, or Blank Plastic
GROUNDING LUG
PAINT

④

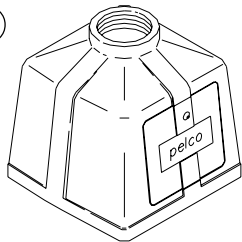

OPTIONS
SETSCREWS IN COLLAR: (1) 3/8" Hex Hd Bolt (3) 3/8" Soc Hd Setscrews
GROUNDING LUG
GALVANIZE
PAINT

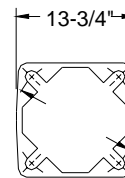

Square Base

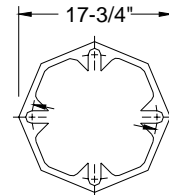

Octagonal Base

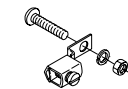

Grounding Lug

⑤

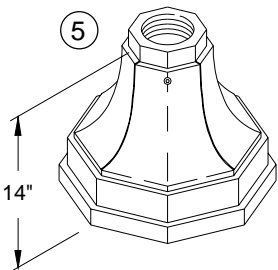

ITEM 5 & 6 OPTIONS
SETSCREWS IN COLLAR: (1) 3/8" Hex Hd Bolt (3) 3/8" Soc Hd Setscrews
GROUNDING LUG
PAINT

⑥

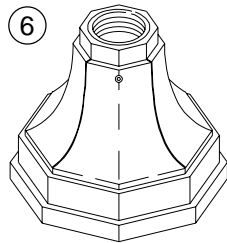

⑦

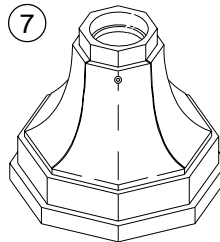

OPTIONS
GROUNDING LUG
PAINT

⑧

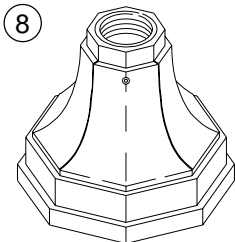

OPTIONS
SETSCREWS IN COLLAR: (1) 3/8" Hex Hd Bolt (3) 3/8" Soc Hd Setscrews
GROUNDING LUG
GALVANIZE
PAINT

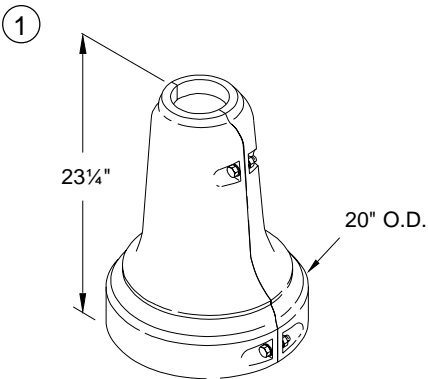

High Density Crosslinkable Polyethylene Pedestal Pole Base for 4 1/2" O.D. poles. Complete with all hardware. No anchor bolts required.

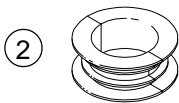

2-Piece Alum Reducer for Item 1.  
(Reduces 4 1/2" O.D. to 3 1/2" O.D.)

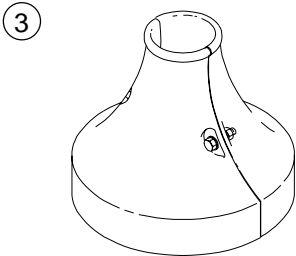

2-Piece Aluminum Base. Complete with all hardware. No anchor bolts required.

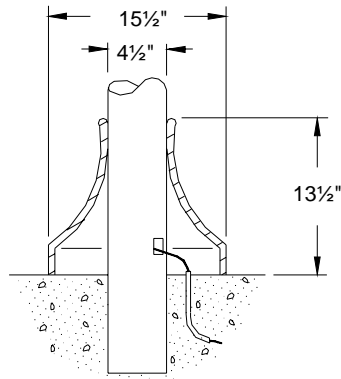

Typical Installation

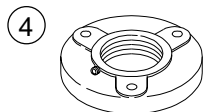

Heavy Duty Galvanized Iron Flange Base. Threaded for 4 1/2" O.D. poles. 13/16" mounting holes. 7 1/4" bolt circle.

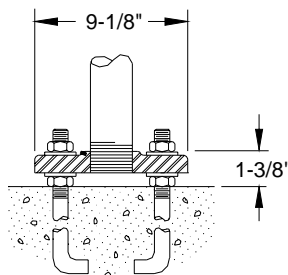

Typical Installation

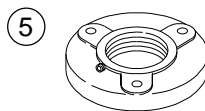

Heavy Duty Aluminum Flange Base. Threaded for 4 1/2" O.D. poles. 13/16" mounting holes. 7 1/4" bolt circle.

ITEM	DESCRIPTION	WEIGHT	PART NO.
①	2-PIECE BASE, Plastic .....	8.0 lbs .....	PB-5303
②	2-PIECE REDUCER, Aluminum .....	.....	PB-5328
③	2-PIECE BASE, Aluminum .....	8.0 lbs .....	PB-5302
④	FLANGE BASE, Galvanized Iron .....	25.5 lbs .....	PB-5304
⑤	FLANGE BASE, Aluminum .....	3.8 lbs .....	PB-5317
⑥	ANCHOR BOLT SET OF 3, 3/4"-10 (Includes 3 Bolts, 6 Washers and 6 Nuts) .....	8.6 lbs .....	PB-5305
⑦	ANCHOR BOLT SET OF 4, 3/4"-10 (Includes 4 each: Bolts, Washers and Nuts) .....	.....	PB-5306
⑧	ANCHOR BOLT CAGE, 13" B.C 3/4"-10 x 18", w/ 36" Rebar & Hardware .....	.....	AP-1095-36
⑨	SHIM, Steel 1/16" x 2" x 2" .....	.....	PB-0602
	1/8" x 2" x 2" .....	.....	PB-0603

